



The synergy of versatility and modularity

Otao Linear

The Otao Linear is the Sylvania's new proposal to those customers who look for a sleek, modular LED lighting system designed for offices or retail environments. Depending on the application this highly adaptable solution can be mounted either standalone or as a continuous, uniform line of light.

The product can be mounted in several ways: ceiling and wall surface-mounted, suspended or ceiling recessed, making it a versatile choice for any design need.

The modularity of the product is almost endless, only the user's imagination can set the limits. All versions are finished in elegant white (RAL9003) or black (RAL9011), ensuring a clean, modern aesthetic that complements any interior design. With its high efficacy of up to 145lm/W, impressive lifespan over 100,000 hours at L80B50 and reliable performance certified by ENEC, the Otao Linear is the perfect choice for those seeking efficient and stylish lighting solutions.

OTAO Linear

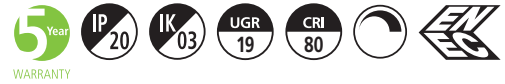

Modular and highly efficient linear range for office and retail applications with several optical and mounting options. The design combines 50mm narrow extruded aluminium profile with several different optical choices to provide the maximum light comfort and efficacy to the customer.

Features

- IP20 ingress protection and IK03 impact protection
- CRI >80 4000/3000K multi CCT light sources with switch button on top of the luminaire
- Multipower dip switch non-dimmable and DALI driver with switch buttons on the top of the luminaire housing – 2-2 power and lumen output options both in case of direct and D/I light distributions
- Replaceable built-in linear Class I drivers
- Luminaires shipped with through wiring
- Luminaire profile length 1147mm
- Up to 145lm/W efficacy @ 4000K
- More optical choices – different UGR levels:
 - Opal diffuser (UGR<25),
 - Prismatic diffuser + lens (UGR<19),
 - Lens combined with white/black/matte silver finishing reflector (UGR<19)
- Several plug and play accessories:
 - Self-test EM non-dimmable and EM DALI addressable module with LiFePO4 battery
 - SylSmart Connected SSA03 module
 - L, T and X connection unit with PCB and Opal diffuser to create lighting systems
 - Separate indirect modules (3 options) as per standard luminaire optical choices with magnetic mounting and pin electrical connection – provides 70/30% D/I light distribution ratio
- Mounting accessories:
 - surface brackets are shipped with the luminaire
 - wall mounting kit
 - suspension kit
 - ceiling rose with 2m cable
 - recessed frame
- 30m long opal rolled diffuser
- White (RAL9003) and black (RAL9011) product finishing
- 102.000 hours L80B50 lifespan

Product information

Code	Description	Light distribution	Optic	Dimmable	Control Technology	Default fixture power [W]	Colour Temp [K]	Luminous Flux 4000K / 3000K [lm]	Efficacy 4000K / 3000K [lm/W]	CRI	UGR
Opal Diffuser											
White (RAL9003) finishing											
0041800	OTAO LINEAR 1.2 OPAL 830/840 MP WH	Direct		-	-	26	3000/4000	3,100/3,250	119/125		
0041801	OTAO LINEAR 1.2 OPAL 830/840 DALI WH			Yes	DALI						
0041800 +	OTAO LINEAR 1.2 OPAL 830/840 MP WH +	Direct/Indirect	Opal Diffuser	-	-	39	3000/4000	4,500/4,850	115/124	>80	<25
0041815	OTAO LINEAR INDIRECT MOD OPAL			Yes	DALI						
0041801 +	OTAO LINEAR 1.2 OPAL 830/840 DALI WH +	Direct/Indirect		-	-	26	3000/4000	2,900/2,750	106/112		
0041815	OTAO LINEAR INDIRECT MOD OPAL			Yes	DALI						
Black (RAL9011) finishing											
0040800	OTAO LINEAR 1.2 OPAL 830/840 MP BK	Direct		-	-	26	3000/4000	2,900/2,750	106/112		
0040801	OTAO LINEAR 1.2 OPAL 830/840 DALI BK			Yes	DALI						
0040800 +	OTAO LINEAR 1.2 OPAL 830/840 MP BK +	Direct/Indirect	Opal Diffuser	-	-	39	3000/4000	4,300/4,600	108/110	>80	<25
0041815	OTAO LINEAR INDIRECT MOD OPAL			Yes	DALI						
0040801 +	OTAO LINEAR 1.2 OPAL 830/840 DALI BK +	Direct/Indirect		-	-	26	3000/4000	2,900/2,750	106/112		
0041815	OTAO LINEAR INDIRECT MOD OPAL			Yes	DALI						
Additional Accessory											
0041815	OTAO LINEAR INDIRECT MOD OPAL	Indirect	-	-	-	11	3000/4000	1,250/1,400	114/127	>80	<25
Prismatic Diffuser + Lens											
White (RAL9003) finishing											
0041802	OTAO LINEAR 1.2 PRIS 830/840 MP WH	Direct		-	-	24	3000/4000	3,200/3,350	133/140		
0041803	OTAO LINEAR 1.2 PRIS 830/840 DALI WH			Yes	DALI						
0041802 +	OTAO LINEAR 1.2 PRIS 830/840 MP WH +	Direct/Indirect	Prismatic Diffuser	-	-	36	3000/4000	4,550/4,850	126/135	>80	<19
0041813	OTAO LINEAR INDIRECT MOD PRIS			Yes	DALI						
0041803 +	OTAO LINEAR 1.2 PRIS 830/840 DALI WH +	Direct/Indirect		-	-	24	3000/4000	3,200/3,350	133/140		
0041813	OTAO LINEAR INDIRECT MOD PRIS			Yes	DALI						
Black (RAL9011) finishing											
0040802	OTAO LINEAR 1.2 PRIS 830/840 MP BK	Direct		-	-	24	3000/4000	3,200/3,350	133/140		
0040803	OTAO LINEAR 1.2 PRIS 830/840 DALI BK			Yes	DALI						
0040802 +	OTAO LINEAR 1.2 PRIS 830/840 MP BK +	Direct/Indirect	Prismatic Diffuser	-	-	36	3000/4000	4,550/4,850	126/135	>80	<19
0041813	OTAO LINEAR INDIRECT MOD PRIS			Yes	DALI						
0040803 +	OTAO LINEAR 1.2 PRIS 830/840 DALI BK +	Direct/Indirect		-	-	24	3000/4000	3,200/3,350	133/140		
0041813	OTAO LINEAR INDIRECT MOD PRIS			Yes	DALI						
Indirect Accessory											
0041813	OTAO LINEAR INDIRECT MOD PRIS	Indirect	-	-	-	10	3000/4000	1,300/1,350	130/135	>80	<25

Product information

Code	Description	Light distribution	Optic	Dimmable	Control Technology	Default fixture power [W]	Colour Temp [K]	Luminous Flux 4000K / 3000K [lm]	Efficacy 4000K / 3000K [lm/W]	CRI	UGR			
Reflector White														
White (RAL9003) finishing														
0041804	OTAO LINEAR 1.2 REF WHT 830/840 MP WH	Direct	Reflector White	-	-	24	3000/4000	3,400/3,500	142/146	>80	<19			
0041805	OTAO LINEAR 1.2 REF WHT 830/840 DALI WH			Yes	DALI									
0041804 +	OTAO LINEAR 1.2 REF WHT 830/840 MP WH +	Direct / Indirect		-	-	36	3000/4000	4,850/5,050	135/140					
0041814	OTAO LINEAR INDIRECT MOD REF													
0041805 +	OTAO LINEAR 1.2 REF WHT 830/840 DALI WH	Direct / Indirect		Yes	DALI	36	3000/4000	4,850/5,050	135/140					
0041814	+ OTAO LINEAR INDIRECT MOD REF													
Black (RAL9011) finishing														
0040804	OTAO LINEAR 1.2 REF WHT 830/840 MP BK	Direct		Reflector White	-	-	24	3000/4000	3,400/3,500			142/146	>80	<19
0040805	OTAO LINEAR 1.2 REF WHT 830/840 DALI BK		Yes		DALI									
0040804 +	OTAO LINEAR 1.2 REF WHT 830/840 MP BK +	Direct / Indirect	-		-	36	3000/4000	4,850/5,050	135/140					
0041814	OTAO LINEAR INDIRECT MOD REF													
0040805 +	OTAO LINEAR 1.2 REF WHT 830/840 DALI BK +	Direct / Indirect	Yes		DALI	36	3000/4000	4,850/5,050	135/140					
0041814	OTAO LINEAR INDIRECT MOD REF													
Indirect accessory														
0041814	OTAO LINEAR INDIRECT MOD REF	Indirect	-		-	-	10	3,000/4,000	1,300/1,400	130/140	>80	<25		
Reflector Black														
White (RAL9003) finishing														
0041823	OTAO LINEAR 1.2 REF BLK 830/840 MP WH	Direct	Reflector Black	-	-	24	3000/4000	3,200/3,350	135/140	>80	<19			
0041824	OTAO LINEAR 1.2 REF BLK 830/840 DALI WH			Yes	DALI									
0041823 +	OTAO LINEAR 1.2 REF BLK 830/840 MP WH +	Direct / Indirect		-	-	36	3000/4000	4,650/4,900	129/136					
0041814	OTAO LINEAR INDIRECT MOD REF													
0041824 +	OTAO LINEAR 1.2 REF BLK 830/840 DALI WH +	Direct / Indirect		Yes	DALI	36	3000/4000	4,650/4,900	129/136					
0041814	OTAO LINEAR INDIRECT MOD REF													
Black (RAL9011) finishing														
0040823	OTAO LINEAR 1.2 REF BLK 830/840 MP BK	Direct		Reflector Black	-	-	24	3000/4000	3,200/3,350			135/140	>80	<19
0040824	OTAO LINEAR 1.2 REF BLK 830/840 DALI BK		Yes		DALI									
0040823 +	OTAO LINEAR 1.2 REF BLK 830/840 MP BK +	Direct / Indirect	-		-	36	3000/4000	4,650/4,900	129/136					
0041814	OTAO LINEAR INDIRECT MOD REF													
0040824 +	OTAO LINEAR 1.2 REF BLK 830/840 DALI BK +	Direct / Indirect	Yes		DALI	36	3000/4000	4,650/4,900	129/136					
0041814	OTAO LINEAR INDIRECT MOD REF													
Indirect accessory														
0041814	OTAO LINEAR INDIRECT MOD REF	Indirect	-		-	-	10	3,000/4,000	1,300/1,400	130/140	>80	<25		
Reflector Silver														
White (RAL9003) finishing														
0041825	OTAO LINEAR 1.2 REF SIL 830/840 MP WH	Direct	Reflector Silver	-	-	24	3000/4000	3,400/3,500	142/146	>80	<19			
0041826	OTAO LINEAR 1.2 REF SIL 830/840 DALI WH			Yes	DALI									
0041825 +	OTAO LINEAR 1.2 REF SIL 830/840 MP WH +	Direct / Indirect		-	-	36	3000/4000	4,850/5,050	135/140					
0041814	OTAO LINEAR INDIRECT MOD REF													
0041826 +	OTAO LINEAR 1.2 REF SIL 830/840 DALI WH	Direct / Indirect		Yes	DALI	36	3000/4000	4,850/5,050	135/140					
0041814	+OTAO LINEAR INDIRECT MOD REF													
Black (RAL9011) finishing														
0040825	OTAO LINEAR 1.2 REF SIL 830/840 MP BK	Direct		Reflector Silver	-	-	24	3000/4000	3,400/3,500			142/146	>80	<19
0040826	OTAO LINEAR 1.2 REF SIL 830/840 DALI BK		Yes		DALI									
0040825 +	OTAO LINEAR 1.2 REF SIL 830/840 MP BK +	Direct / Indirect	-		-	36	3000/4000	4,850/5,050	135/140					
0041814	OTAO LINEAR INDIRECT MOD REF													
0040826 +	OTAO LINEAR 1.2 REF SIL 830/840 DALI BK +	Direct / Indirect	Yes		DALI	36	3000/4000	4,850/5,050	135/140					
0041814	OTAO LINEAR INDIRECT MOD REF													
Indirect accessory														
0041814	OTAO LINEAR INDIRECT MOD REF	Indirect	-		-	-	10	3,000/4,000	1,300/1,400	130/140	>80	<25		

OTAO Linear

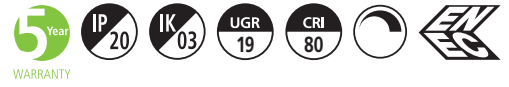

Additional images

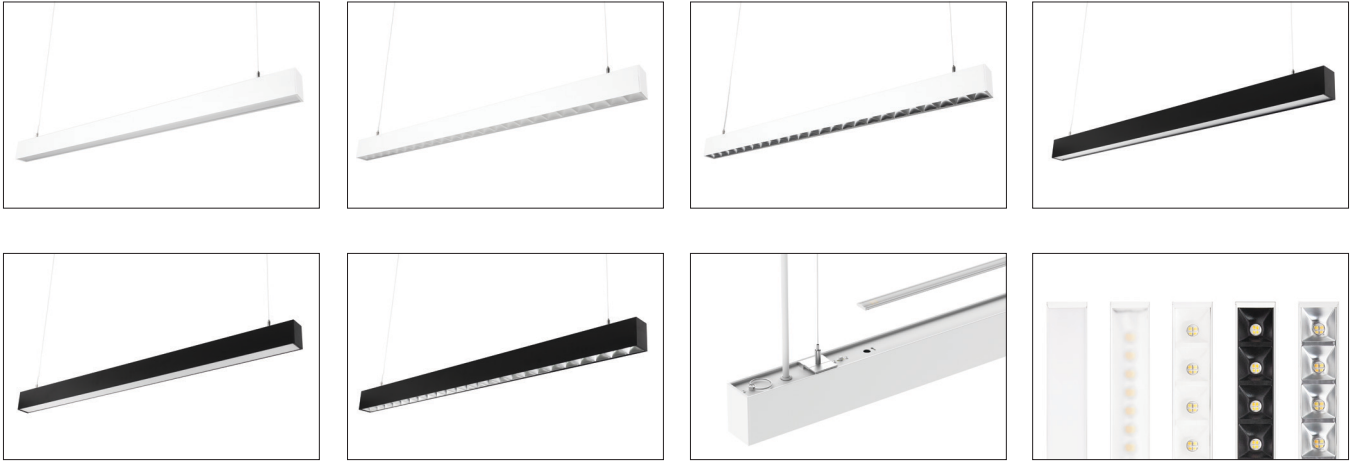

Photometric Data

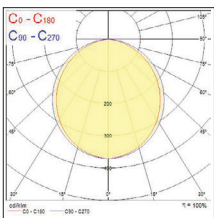

Opal Direct

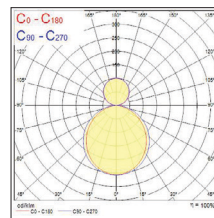
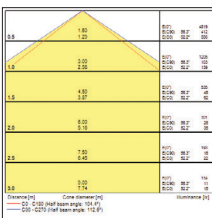

Prismatic Direct/Indirect

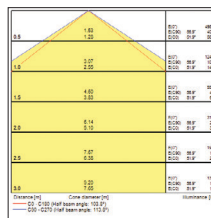

Reflector Direct

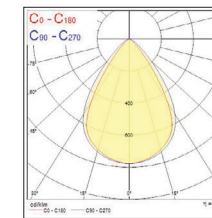

Reflector Direct/Indirect

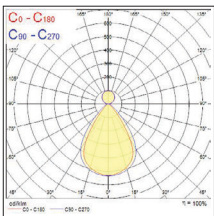

Opal Direct

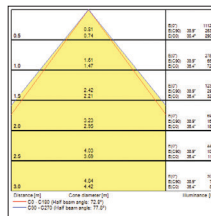
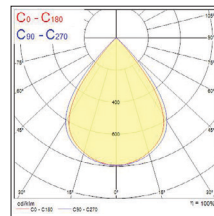
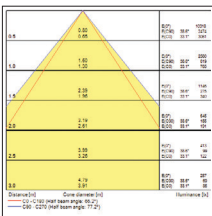

Dimensions (mm) - Luminaires

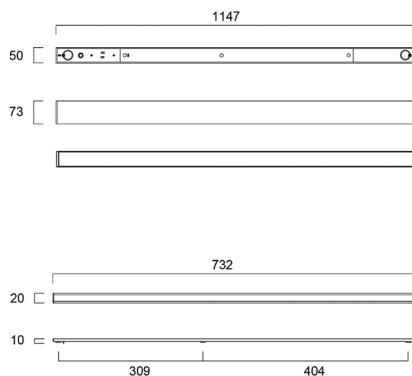
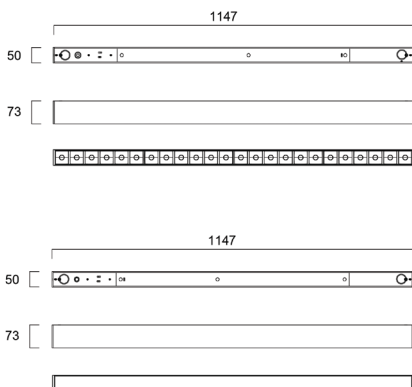

OTAO Linear



Otao Linear Wall Mounted



Otao Linear Suspended

Accessories

Code	Description	Comments
Electrical Accessories		
0041809	OTAO LINEAR CORN-L OPAL 830/840 WH	L-shape connection unit w/o driver, incl PCB, Opal Diffuser, only downlight, white (RAL9003) finishing, with 2x straight connectors + spare electrical connectors (2pcs)
0041810	OTAO LINEAR CORN-T OPAL 830/840 WH	T-shape connection unit w/o driver, incl PCB, Opal Diffuser, only downlight, white (RAL9003) finishing, with 3x straight connectors + spare electrical connectors (3pcs)
0041811	OTAO LINEAR CORN-X OPAL 830/840 WH	X-shape connection unit w/o driver, incl PCB, Opal Diffuser, only downlight, white (RAL9003) finishing, with 4x straight connectors + spare electrical connectors (4pcs)
0040809	OTAO LINEAR CORN-L OPAL 830/840 BK	L-shape connection unit w/o driver, incl PCB, Opal Diffuser, only downlight, black (RAL9011) finishing, with 2x straight connectors + spare electrical connectors (2pcs)
0040810	OTAO LINEAR CORN-T OPAL 830/840 BK	T-shape connection unit w/o driver, incl PCB, Opal Diffuser, only downlight, black (RAL9011) finishing, with 3x straight connectors + spare electrical connectors (3pcs)
0040811	OTAO LINEAR CORN-X OPAL 830/840 BK	X-shape connection unit w/o driver, incl PCB, Opal Diffuser, only downlight, black (RAL9011) finishing, with 4x straight connectors + spare electrical connectors (4pcs)
0041812	OTAO LINEAR SSA03 MODULE WH	SSA sensor module, DALI PS, 2x ALU extrusion for mechanical connection + electrical wiring, white (RAL9003)
0040812	OTAO LINEAR SSA03 MODULE BK	SSA sensor module, DALI PS, 2x ALU extrusion for mechanical connection + electrical wiring, black (RAL9011)
0041827	OTAO LINEAR ST EM MODULE WH	Self-Test on/off emergency module with EM indicator and LiFePO4 battery (no Self-Test button) + 2x ALU extrusion for mechanical connection + electrical wiring, white (RAL9003)
0041822	OTAO LINEAR ST EMPRO MODULE WH	Self-Test module DALI functions with EM indicator and LiFePO4 battery (no Self-Test button) + 2x ALU extrusion for mechanical connection + electrical wiring, white (RAL9003)
0040827	OTAO LINEAR ST EM MODULE BK	Self-Test on/off emergency module with EM indicator and LiFePO4 battery (no Self-Test button) + 2x ALU extrusion for mechanical connection + electrical wiring, black (RAL9011)
0040822	OTAO LINEAR ST EMPRO MODULE BK	Self-Test module DALI functions with EM indicator and LiFePO4 battery (no Self-Test button) + 2x ALU extrusion for mechanical connection + electrical wiring, black (RAL9011)
0041818	OTAO LINEAR CEILING ROSE WH 5-PIN	ceiling rose for mounting of on/off or DALI luminaires incl 5-pin terminal and 2.0m long wire, white (RAL9003)
0041828	OTAO LINEAR CEILING ROSE WH 6-PIN	ceiling rose for mounting of on/off or DALI EM luminaires incl 6-pin terminal and 2.0m long wire, white (RAL9003)
0040818	OTAO LINEAR CEILING ROSE BK 5-PIN	ceiling rose for mounting of on/off or DALI luminaires incl 5-pin terminal and 2.0m long wire, black (RAL9011)
0040828	OTAO LINEAR CEILING ROSE BK 6-PIN	ceiling rose for mounting of on/off or DALI EM luminaires incl 6-pin terminal and 2.0m long wire, black (RAL9011)
Optical accessories		
0041815	OTAO LINEAR INDIRECT MOD OPAL	up-light module for luminaires with Opal Diffuser
0041813	OTAO LINEAR INDIRECT MOD PRIS	up-light module for luminaires with Clear Diffuser + lenses
0041814	OTAO LINEAR INDIRECT MOD REF	up-light module for luminaires with Reflector
0041806	OTAO LINEAR REF WHT 4PCS	reflector replacement spare part with LEDs - white finishing (4pcs per pack = 1 luminaire)
0041807	OTAO LINEAR REF BLK 4PCS	reflector replacement spare part with LEDs - black finishing (4pcs per pack = 1 luminaire)
0041808	OTAO LINEAR REF SIL 4PCS	reflector replacement spare part with LEDs - silver finishing (4pcs per pack = 1 luminaire)
Mechanical accessories		
0041816	OTAO LINEAR WALL MOUNTING KIT	2 pcs of L shape steel mounting bracket for mounting of 1 luminaire
0041819	OTAO LINEAR SUSPENSION KIT	2 pcs of steel of 1.5m long of suspension cables for pendant mounting of 1 luminaire
0041820	OTAO LINEAR FAST CONNECTOR	mechanical connector to build continuous line of luminaires (1pce)
0041821	OTAO LINEAR OPAL ROLLED DIFF 30M	diffuser to build seamless continous line for luminaires with Opal diffuser
0041829	OTAO LINEAR RECESSED FRAME WH	recessed mounting frame with trim, 1.2m length, white (RAL9003)
0040829	OTAO LINEAR RECESSED FRAME BK	recessed mounting frame with trim, 1.2m length, black (RAL9011)

OTAO Linear

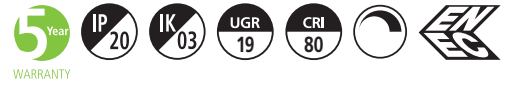

Additional images

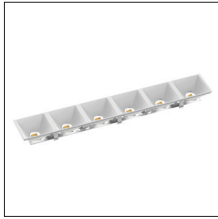

0041806



0041807



0041808

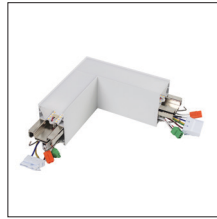

0041809

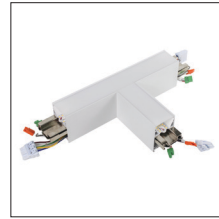

0041810

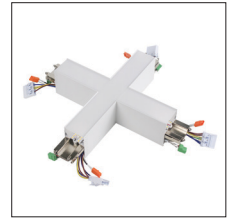

0041811



0041812



0040812

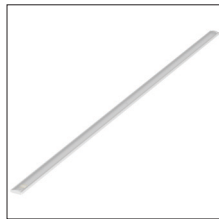

0041813 / 0041814 / 0041815

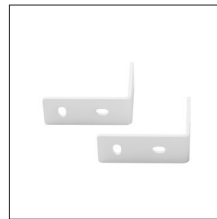

0041816



0040818 / 0040828



0041818 / 0041828



0041819

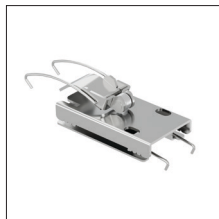

0041820



0041821

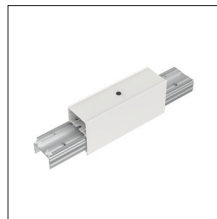

0041827 / 0041822



0040827 / 0040822



0041829



0040809

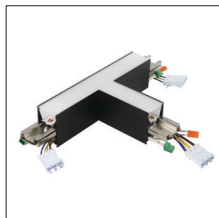

0040829

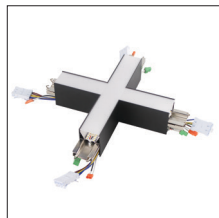

0040811



0040829

OTAO Linear



Dimensions (mm) - Accessories

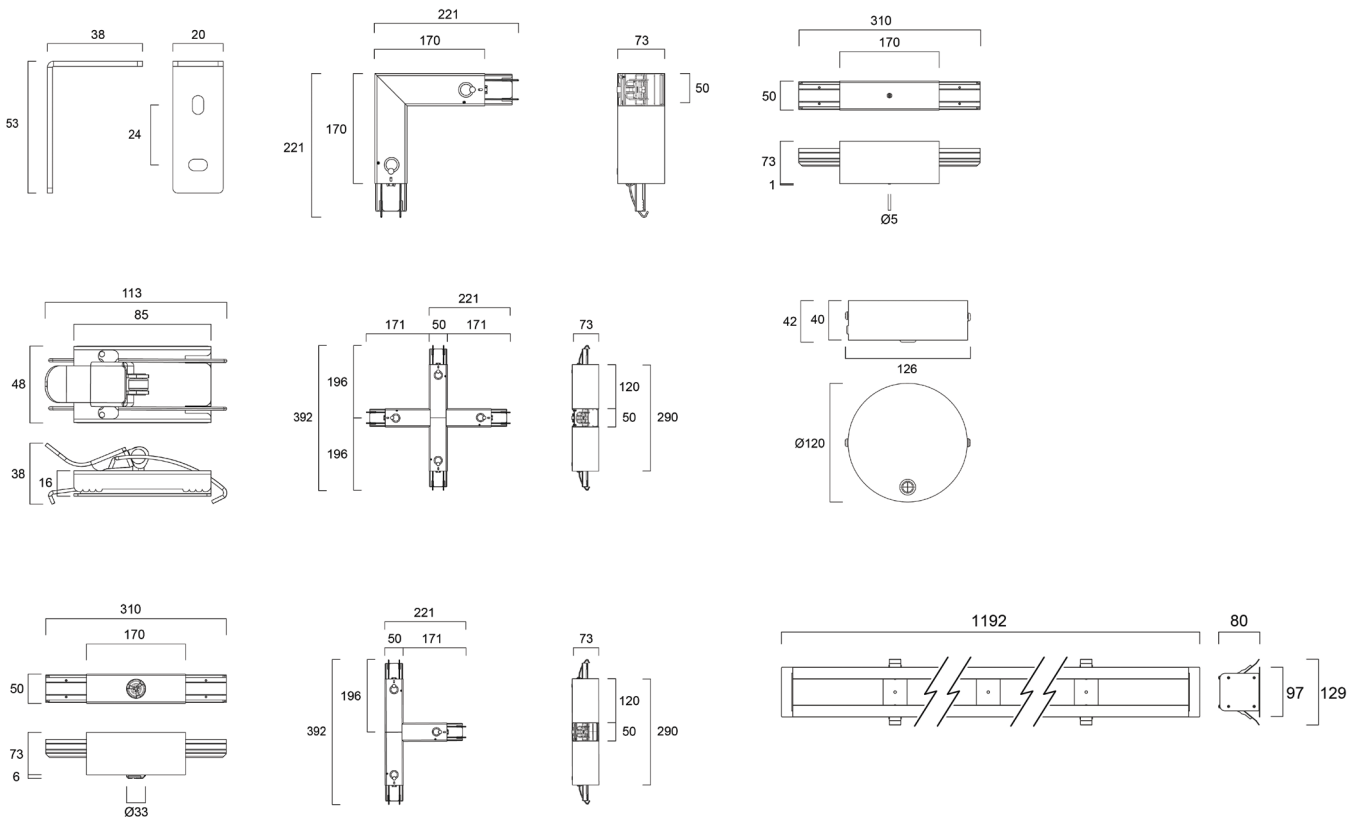

Connection Units

CCT	Code	Description	Light distribution - standard luminaire	No of connected luminaires	Luminous flux [lm] - connection unit	Efficacy [lm/W] - connection unit
White (RAL9003) versions						
3000/4000	0041809	OTAO LINEAR CORN-L OPAL 830/840 WH	Direct	2	550/600	120/130
		OTAO LINEAR CORN-L OPAL 830/840 WH	Direct	2	590/640	120/131
		OTAO LINEAR CORN-L OPAL 830/840 WH	Direct/Indirect	2	590/640	120/131
		OTAO LINEAR CORN-L OPAL 830/840 WH	Direct/Indirect	2	630/700	119/132
3000/4000	0041810	OTAO LINEAR CORN-T OPAL 830/840 WH	Direct	3	825/900	120/130
		OTAO LINEAR CORN-T OPAL 830/840 WH	Direct	3	885/960	118/128
		OTAO LINEAR CORN-T OPAL 830/840 WH	Direct/Indirect	3	885/960	118/128
		OTAO LINEAR CORN-T OPAL 830/840 WH	Direct/Indirect	3	945/1050	118/131
3000/4000	0041811	OTAO LINEAR CORN-X OPAL 830/840 WH	Direct	4	1100/1200	120/130
		OTAO LINEAR CORN-X OPAL 830/840 WH	Direct	4	1180/1280	120/131
		OTAO LINEAR CORN-X OPAL 830/840 WH	Direct/Indirect	4	1180/1280	120/131
		OTAO LINEAR CORN-X OPAL 830/840 WH	Direct/Indirect	4	1260/1400	116/128
Black (RAL9011) versions						
3000/4000	0040809	OTAO LINEAR CORN-L OPAL 830/840 BK	Direct	2	490/540	107/117
		OTAO LINEAR CORN-L OPAL 830/840 BK	Direct	2	520/570	106/116
		OTAO LINEAR CORN-L OPAL 830/840 BK	Direct/Indirect	2	520/570	106/116
		OTAO LINEAR CORN-L OPAL 830/840 BK	Direct/Indirect	2	560/620	106/117
3000/4000	0040810	OTAO LINEAR CORN-T OPAL 830/840 BK	Direct	3	730/800	106/116
		OTAO LINEAR CORN-T OPAL 830/840 BK	Direct	3	790/860	105/115
		OTAO LINEAR CORN-T OPAL 830/840 BK	Direct/Indirect	3	790/860	105/115
		OTAO LINEAR CORN-T OPAL 830/840 BK	Direct/Indirect	3	840/940	105/118
3000/4000	0040811	OTAO LINEAR CORN-X OPAL 830/840 BK	Direct	4	980/1070	107/116
		OTAO LINEAR CORN-X OPAL 830/840 BK	Direct	4	1050/1140	107/116
		OTAO LINEAR CORN-X OPAL 830/840 BK	Direct/Indirect	4	1050/1140	107/116
		OTAO LINEAR CORN-X OPAL 830/840 BK	Direct/Indirect	4	1120/1250	103/115

Connection units are available only with Opal diffuser

Indirect Modules Compatibility Matrix

Optic	Code	Indirect Module			
		0041815	0041813	0041814	
Standard Luminaire	Opal diffuser	0041800 / 0041801 0040800 / 0040801	✓	✗	✗
	Prismatic diffuser	0041802 / 0041803 0040802 / 0040803	✗	✓	✗
	Reflector White	0041804 / 0041805 0040804 / 0040805	✗	✗	✓
	Reflector Black	0041823 / 0041824 0040823 / 0040824	✗	✗	✓
	Reflector Silver	0041825 / 0041826 0040825 / 0040826	✗	✗	✓

Indirect module to be ordered separately

Otao Linear - luminous flux of linear product in EM mode

Code	Description	Light distribution	Dimmable	Control Technology	Optic	Colour Temp [K]	EM module additional power [W]	Luminous Flux 3000K / 4000K [lm]	Efficacy 3000K / 4000K [lm/W]	CRI
Opal Diffuser										
White (RAL9003) finishing										
0041800	OTAO LINEAR 1.2 OPAL 830/840 MP WH	Direct	-	-	Opal Diffuser	3,000/4,000	2	230/250	115/125	>80
0041801	OTAO LINEAR 1.2 OPAL 830/840 DALI WH		Yes	DALI						
Black (RAL9011) finishing										
0040800	OTAO LINEAR 1.2 OPAL 830/840 MP BK	Direct	-	-	Opal Diffuser	3,000/4,000	2	210/230	105/105	>80
0040801	OTAO LINEAR 1.2 OPAL 830/840 DALI BK		Yes	DALI						
Prismatic Diffuser + Lens										
White (RAL9003) finishing										
0041802	OTAO LINEAR 1.2 PRIS 830/840 MP WH	Direct	-	-	Prismatic Diffuser	3,000/4,000	2	300/310	150/155	>80
0041803	OTAO LINEAR 1.2 PRIS 830/840 DALI WH		Yes	DALI						
Black (RAL9011) finishing										
0040802	OTAO LINEAR 1.2 PRIS 830/840 MP BK	Direct	-	-	Prismatic Diffuser	3,000/4,000	2	300/310	150/155	>80
0040803	OTAO LINEAR 1.2 PRIS 830/840 DALI BK		Yes	DALI						
Reflector White										
White (RAL9003) finishing										
0041804	OTAO LINEAR 1.2 REF WHT 830/840 MP WH	Direct	-	-	Reflector White	3,000/4,000	2	300/310	150/155	>80
0041805	OTAO LINEAR 1.2 REF WHT 830/840 DALI WH		Yes	DALI						
Black (RAL9011) finishing										
0040804	OTAO LINEAR 1.2 REF WHT 830/840 MP BK	Direct	-	-	Reflector White	3,000/4,000	2	300/310	150/155	>80
0040805	OTAO LINEAR 1.2 REF WHT 830/840 DALI BK		Yes	DALI						
Reflector Black										
White (RAL9003) finishing										
0041823	OTAO LINEAR 1.2 REF BLK 830/840 MP WH	Direct	-	-	Reflector Black	3,000/4,000	2	300/310	150/155	>80
0041824	OTAO LINEAR 1.2 REF BLK 830/840 DALI WH		Yes	DALI						
Black (RAL9011) finishing										
0040823	OTAO LINEAR 1.2 REF BLK 830/840 MP BK	Direct	-	-	Reflector Black	3,000/4,000	2	300/310	150/155	>80
0040824	OTAO LINEAR 1.2 REF BLK 830/840 DALI BK		Yes	DALI						
Reflector Silver										
White (RAL9003) finishing										
0041825	OTAO LINEAR 1.2 REF SIL 830/840 MP WH	Direct	-	-	Reflector Silver	3,000/4,000	2	300/310	150/155	>80
0041826	OTAO LINEAR 1.2 REF SIL 830/840 DALI WH		Yes	DALI						
Black (RAL9011) finishing										
0040825	OTAO LINEAR 1.2 REF SIL 830/840 MP BK	Direct	-	-	Reflector Silver	3,000/4,000	2	300/310	150/155	>80
0040826	OTAO LINEAR 1.2 REF SIL 830/840 DALI BK		Yes	DALI						

OTAO Linear



SYLVANIA



CE UK
CA

in f  

Although every effort has been made to ensure accuracy in the compilation of the technical detail within this publication, specifications and performance data are constantly changing. Current details should therefore be checked with Feilo Sylvania International Group Kft.

Copyright Feilo Sylvania International Group Kft. February 2025

sylvania-group.com

A Feilo Sylvania Company